

WISAIR

Oil-free Compressors

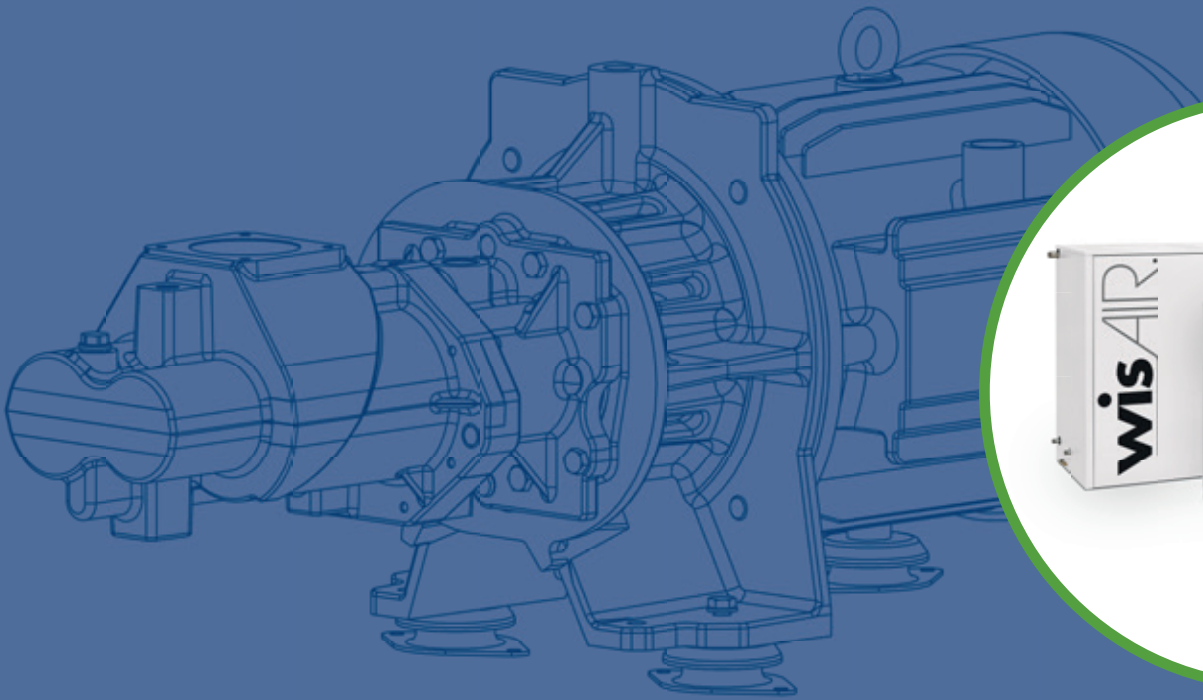

WIS 20-75V

Oil free
compressors

Oil-free compressors

Industries such as pharmaceuticals, food and beverage, electronics and textiles cannot risk any chance of oil contamination in their processes. Therefore, it is essential that the compressed air is 100% oil-free. The standard is ISO 8573-1 (2010) certification, in which Class Zero represents the highest air purity. It is the only way to ensure oil-free air for your critical processes and with it peace of mind.

Outstanding reliability, low maintenance and operating costs make oil-free compressors a sound investment.

www.oilfreecompressors.eu



The power of our oil-free screw range

WIS 20-75V oil-free compressors provide high-quality compressed air for a range of industrial applications. The continuous investment in product development has resulted in both economical and ecological compressors. The range is built focusing on three pillars to make them stand out.

Oil-free quality air

- Ultimate 100% oil free, clean air.
- The integrated air dryer enhances the air quality and protects your air network against corrosion.

Energy efficiency

- The most energy efficient compression due to low air discharge temperatures, optimized rotor profiles and no bearing losses.
- Integrated inverter technology assures a perfect match of air supply and air demand eliminating no load power losses.
- Direct driven no loss drive train.
- Graphic, full color screen controller with intelligent energy saving features.

Ultimate reliability

- Friction free hydrodynamic bearings lubricated by clean, filtered lubricant.
- Durable materials to exclude any risk of corrosion.
- Reduced rotor stresses due to soft start up process.

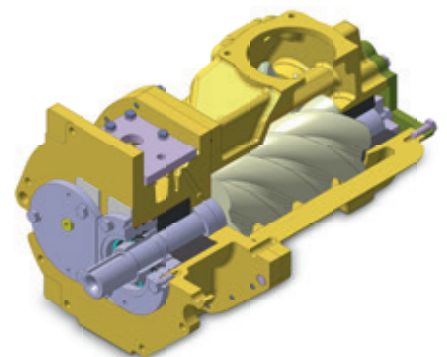

When technology and ecology join forces

The WIS 20-75V range combines the user benefits and compressor features that matter most. All integrated into one concept!

Premium performance

- Pressure rating up to 13 bar.
- Output from 306 to 504 m³/h
- 85 to 140 l/s - 180 to 296 cfm.
- Radial cooling fan (air-cooled versions only) and sound-absorbing cabinet for premium cooling and noise performance.

Premium efficiency

- Unique isotherm compression brings premium saving.
- Inverter driven technology provides up to 35% energy savings.
- Limited pressure band results in an overall reduced net pressure (1 bar extra pressure = 7% energy).
- 3.5" graphic full color controller with web visualization and intelligent saver cycles.
- Friction free air end bearings.
- Direct driven power train to reduce energy losses.
- Built-in dryer to reduce downstream pressure drop.

Premium quality

- ISO 8573-1 **Class 0*** certified quality air.
- Integrated dryer guaranteeing PDP < 3°C.
- Corrosion proof materials: aluminium bronze rotor housing, stainless steel rotor shaft, piping and separator vessel.
- Smooth start up with inverter driven technology.
- Clean piping.

CLASS*	Concentration total oil (aerosol, liquid, vapour) mg/m ³
0	As specified by the equipment user or supplier and more stringent than class 1
1	≤ 0,01
2	≤ 0,1
3	≤ 1
4	≤ 5



Energy audit

To optimize your energy efficiency, you need to select the right compressor. Contact your local representative and we will perform a simulation based on your parameters to help you get the perfect compressed air solution.

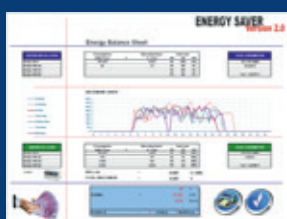

One package – multiple benefits

Check out these innovative features of the WIS 20-75V range and see how they provide you with maximized efficiency, excellent air quality and low noise levels.

Direct drive set

- IP55 induction motor directly coupled to the air end.
- No long-term losses.
- Direct drive train for optimum efficiency.
- Flexible to meet pressure/flow requirement.

In-house designed element

- Highly efficient profile.
- Corrosion-proof parts.
- Hydrodynamic bearings.



Integrated inverter

- Optimum zone control to optimize energy cost.
- Forced cooling air flow over electronics and smooth start-up to guarantee longer lifetime.
- More than 30% potential savings.



Graphic controller

- All readings and controls from full color screen controller.
- Data logging possibility.
- Web visualization.
- Integrated sequencer.
- Standard on the WIS 20-75V range.





Integrated dryer

- Integrated into the package to reduce footprint, maintenance and installation cost.
- Designed to guarantee a constant pressure dew point of 3°C.
- All readings/control function from one point.

Sound insulated canopy

Allows installation in most working environments without requiring a separate compressor room.

Radial fan & cooling system

- The cooling turbine is installed in an easily accessible sound insulated cabinet.
- Oversized cooler pack to enhance cooling performance.
- Maintaining a high cooling efficiency, the radial cooling turbine reduces the energy consumption.



WISAIR sets modern industry standards



**PHARMACEUTICAL
INDUSTRY**



MEDICAL

1992

FIRST WATER INJECTED
SCREW COMPRESSOR
INSTALLED

1993

FIRST AIR-COOLED
PACKAGE

1998

INTRODUCTION INVERTER
DRIVEN TECHNOLOGY
IN WIS



ELECTRONICS

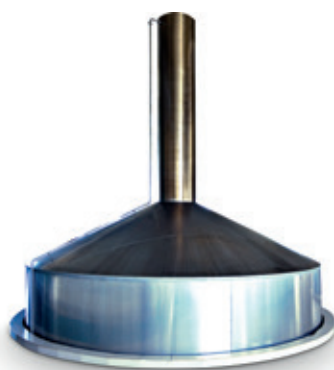

FOOD & BREWERY



CHEMICALS & PLASTICS



2001
INTRODUCTION
INTEGRATED DRYER
PACK

OIL-FREE

RANGE REWARDED
BY CLASS ZERO ISO
CERTIFICATION



Class zero guarantees the ultimate air quality for all those applications that require perfectly clean air:

- Pharmaceuticals
- Food and beverages
- Textile industry
- Electronics

With our oil-free screw compressor range we meet your mandatory requirements to avoid oil traces in the output air according to ISO 8573-1.

ENERGY SAVINGS PUSHED TO THE LIMIT

Savings from the oil-free air end

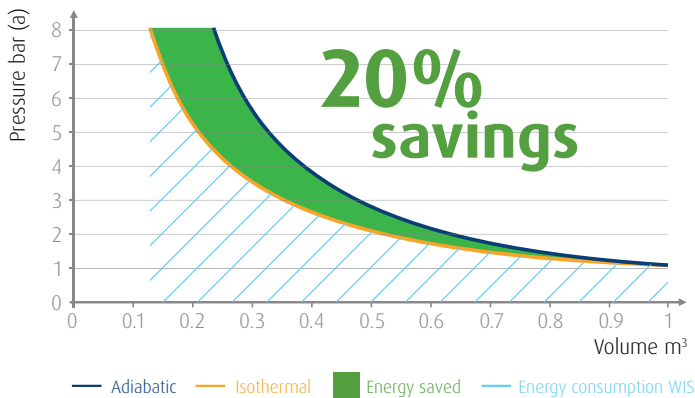

Limited temperature increase of only 25° C inside compressor element

Adiabatic compression: All compression heat is transferred to the compressed air (~ dry screw technology)

Isothermal compression: Constant temperature in compression chamber (~ WIS technology)

The WIS 20-75V range offers nearly isothermal compression. Superior air end cooling results in more compressed air for lower energy consumption.

Savings from state-of-the-art installation

- Reduced installation costs:
 - o No filter maintenance costs.
 - o No pressure drop.
 - o No condensate treatment.
 - o No contamination.
- Reduced noise level even with multiple installations.
- Small footprint compared to conventional installation.
- Single central control point for multiple unites with integrated sequencer or wall-mounted controller.



Savings from inverter technology

Energy costs represent about 70% of the total operating cost of your compressor over a 5-year period. That is why reducing the operating cost of a compressed air solution is a major focus. The WIS oil-free screw compressor can cut the energy bill of your compressor by up to 30%.

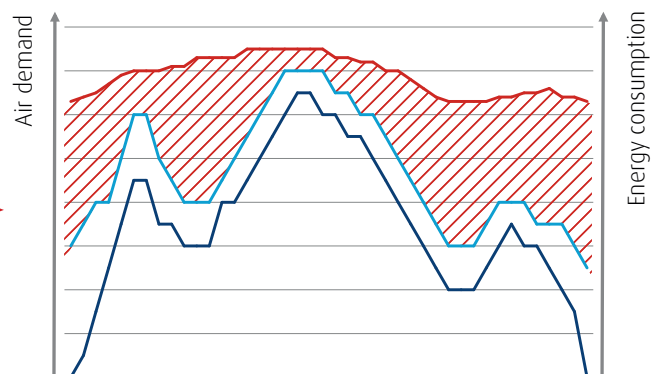
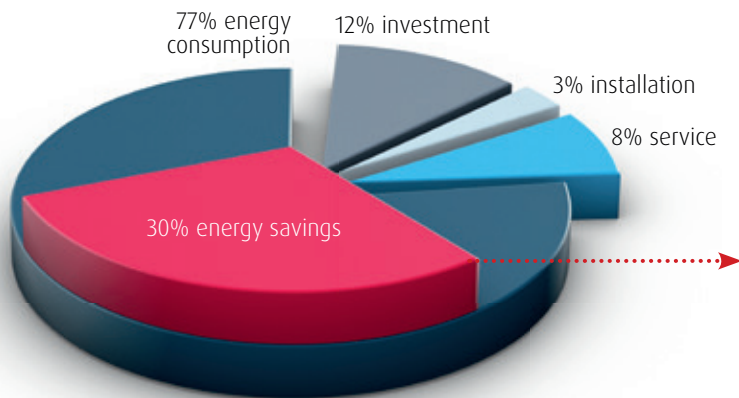

Energy cost is reduced because:

- The no load power is eliminated.
- A stable net pressure is maintained.
- There are no current peaks due to soft start.

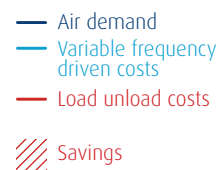

Savings from the controller

- Instant pressure logging and communication limits the pressure band and reduces the average net pressure.
- Integrated saver cycles to limit energy consumption and optimize air quality.
- Integrated sequencer for 4 up to 6 compressors limiting the energy consumption and equalizing running hours.
- Dual pressure band operation.



Options to optimize your operations



A wide range of options enables you to get the most out of your WIS 20-75V compressor.

General options

- Booster pump
- Flanged inlet
- Anchor pads
- IT ancillaries

Air treatment

- Dryer bypass for unbreakable production

Protection

- Water shut-off valve
- Main power isolator switch

For further information on how our options can optimize your operations, please contact your local representative.



Technical specifications

Inverter version

Model	Max. working pressure	Reference working pressure	Free Air Delivery			Motor power		Noise level	Cooling air volume	Weight		Compressed air outlet diameter
	bar	bar	m ³ /h	l/s	cfm	kW	hp	dB(A)	m ³ /h	std (kg)	T (kg)	
WIS 20V	13	7	78-168	22-47	47-100	15	20	67	1080	650	700	1
WIS 25V	13	7	78-192	22-54	47-114	18	25	69	1440	650	700	
WIS 30V	13	7	78-240	22-66	47-140	22	30	70	10080	740	800	
WIS 40V	13	7	78-300	22-83	47-176	30	40	72	10040	740	810	
WIS 50V	13	7	150-372	42-104	89-220	37	50	69	11880	1195	1306	1 1/2
WIS 75V	13	7	150-556	42-155	90-328	55	75	72	16200	1195	1314	

Fixed Speed version

Model	Max. working pressure	Reference working pressure	Free Air Delivery			Motor power		Noise level	Cooling air volume	Weight		Compressed air outlet diameter
	bar	bar	m ³ /h	l/s	cfm	kW	hp	dB(A)	m ³ /h	std (kg)	T (kg)	
WIS 40	7.5	7	306	84.9	180.1	30	40	68	11520	1226	1320	1 1/2
	10	9.5	246	69.3	144.8	30	40	68				
	13	12.5	192	53,0	113,0	30	40	68				
WIS 50	7.5	7	366	1.2	215.4	37	50	69	11880	1298	1395	
	10	9.5	312	86.4	183.6	37	50	69				
	13	12.5	252	69.2	148.3	37	50	69				
WIS 60	7.5	7	438	121.4	257.8	45	60	71	15840	1321	1416	1 1/2
	10	9.5	354	98.1	208.4	45	60	71				
	13	12.5	294	82.2	173,0	45	60	71				
WIS 75	7.5	7	504	139.1	296.6	55	75	72	16200	1378	1497	
	10	9.5	426	118.1	250.7	55	75	72				
	13	12.5	354	98.4	208.4	55	75	72				

Dimensions

Model	Length std mm	Width mm	Height mm
WIS 40	2435	965	1840
WIS 50			
WIS 60			
WIS 75			
Model	Length mm	Width mm	Height mm
WIS 20V	1976	974	1500
WIS 25V			
WIS 30V			
WIS 40V	2435	965	1840
WIS 50V			
WIS 75V			





DRIVEN BY TECHNOLOGY DESIGNED BY EXPERIENCE



CONTACT YOUR LOCAL SALES REPRESENTATIVE



Care. Trust. Efficiency.

Care.

Care is what service is all about: professional service by knowledgeable people, using high-quality original parts.

Trust.

Trust is earned by delivering on our promises of reliable, uninterrupted performance and long equipment lifetime.

Efficiency.

Equipment efficiency is ensured by regular maintenance. Efficiency of the service organization is how Original Parts and Service make the difference.